

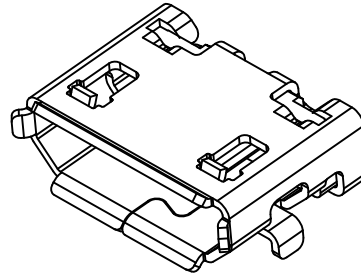

PART NUMBER

10118194-0001LF

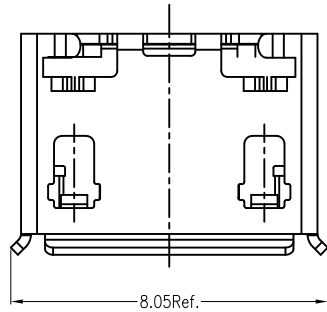

NOTES:

- 1. MATERIAL:
HOUSING: HIGH THERMOPLASTIC RESIN, UL94V-0, COLOR: BLACK
TERMINAL: COPPER ALLOY
SHELL: STAINLESS
- 2. FINISH:
CONTACT AREA: GOLD PLATED
CONTACT SOLDER AREA: GOLD FLASH
SHELL: MATTE TIN PLATED
UNDER NICKEL PLATED ALL OVER.
- 3. PRODUCT SPECIFICATION: GS-12-641.
- 4. PACKAGING SPECIFICATION: GS-14-2180.
- 5. THE "LF" MEANS FOR LEAD FREE AND CAN WITHSTAND EXPOSE TO 260°C PEAK TEMPERATURE FOR 10 SECONDS IN IR REFLOW PROCESS.

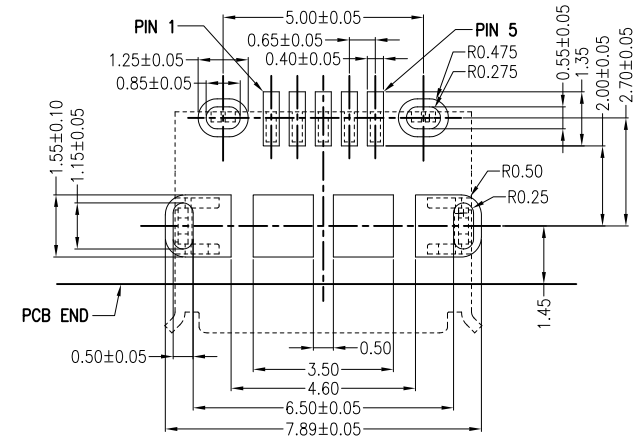
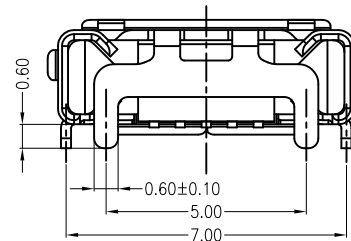
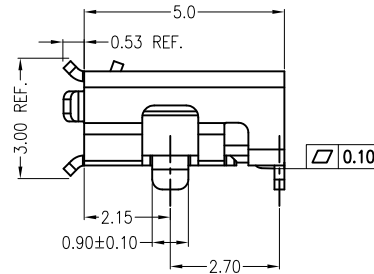
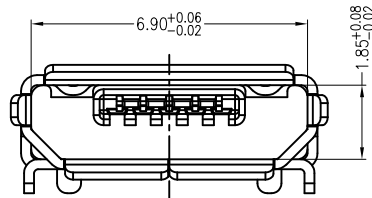

REFERENCE PCB LAYOUT

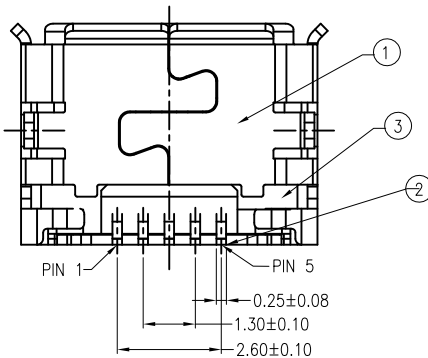

Item	Title	Q'TY
1	Shell	1
2	Terminal	5
3	InsertMolding	1

mat'l. code		surface ASME Y14.5 ✓		tolerance ASME Y14.5		projection 		product family USB	
ltr		ecn no		dr		date		tolerances unless otherwise specified	
A				LS		10/21/11		title MICRO USB B TYPE RECEPTACLE	
								MM	
								scale	
								FCI	
								dwg no 10118194	
								sheet 1 of 1	
								size A4	
								type CUSTOMER Drawing	
sheet index		revision sheet		A		1			

A

5

B

A

B